

PR Series

Cylindrical type proximity sensor

■ Features

- Improved the noise resistance with dedicated IC (DC 3-wire)
- Reverse power polarity, surge, overcurrent protection
(Except for PR08 Series.)
- Long life cycle and reliable simple operation
- Red LED status indication
- IP67 rated waterproof structure (IEC standard)
- Replacer for micro switches and limit switches



⚠ Please read "Caution for your safety" in operation manual before using.



■ Specifications

● DC 2-wire type

Model	PRT08-1.5DO PRT08-1.5DC	PRT08-2DO PRT08-2DC	PRT12-2DO PRT12-2DC	PRT12-4DO PRT12-4DC	PRT18-5DO PRT18-5DC	PRT18-8DO PRT18-8DC	PRT30-10DO PRT30-10DC	PRT30-15DO PRT30-15DC
Sensing distance	1.5mm ±10%	2mm ±10%	2mm ±10%	4mm ±10%	5mm ±10%	8mm ±10%	10mm ±10%	15mm ±10%
Hysteresis	Max. 10% of sensing distance							
Standard sensing target	8×8×1mm (Iron)		12×12×1mm (Iron)		18×18×1mm (Iron)	25×25×1mm (Iron)	30×30×1mm (Iron)	45×45×1mm (Iron)
Setting distance	0 ~ 1.05mm	0 ~ 1.4mm	0 ~ 1.4mm	0 ~ 2.8mm	0 ~ 3.5mm	0 ~ 5.6mm	0 ~ 7mm	0 ~ 10.5mm
Power supply (Operation voltage)	24VDC (15-30VDC)							
Leakage current	Max. 0.6mA							
Response frequency(*1)	1.5kHz	1kHz	1.5kHz	500Hz		350Hz	400Hz	200Hz
Residual voltage	Max. 7V							
Affection by Temp.	±10% Max. for sensing distance at +20°C within temperature range of -25 ~ +70°C							
Control output	2 ~ 100mA							
Insulation resistance	Min. 50MΩ (at 500VDC mega)							
Dielectric strength	1500VAC 50/60Hz for 1minute							
Vibration	1mm amplitude at frequency of 10 ~ 55Hz in each of X, Y, Z directions for 2 hours							
Shock	500m/s ² (50G) in X, Y, Z direction for 3 times							
Indicator	Operation indicator (Red LED)							
Ambient temperature	-25 ~ +70°C (at non-freezing status)							
Storage temperature	-30 ~ +80°C (at non-freezing status)							
Ambient humidity	35 ~ 95%RH							
Protection circuit	Surge, Overcurrent protection circuit							
Protection	IP67 (IEC standard)							
Cable spec.	φ 4×2P, 2m				φ 5×2P, 2m			
Approval	CE							
Unit weight	Approx.36g	Approx.36g	Approx.63g	Approx.63g	Approx.122g	Approx.122g	Approx.181g	Approx.181g

*(*1) The response frequency is the average value. The standard sensing target is used and the width is set as 2 times of the standard sensing target, 1/2 of the sensing distance for the distance.

Cylindrical Type Proximity Sensor

●DC 3-wire type

Model	PR08-1.5DN	PR08-2DN	PR12-2DN	PR12-4DN	PR18-5DN	PR18-8DN	PR30-10DN	PR30-15DN
	PR08-1.5DP	PR08-2DP	PR12-2DP	PR12-4DP	PR18-5DP	PR18-8DP	PR30-10DP	PR30-15DP
	PR08-1.5DN2	PR08-2DN2	PR12-2DN2	PR12-4DN2	PR18-5DN2	PR18-8DN2	PR30-10DN2	PR30-15DN2
	PR08-1.5DP2	PR08-2DP2	PR12-2DP2	PR12-4DP2	PR18-5DP2	PR18-8DP2	PR30-10DP2	PR30-15DP2
	PRL08-1.5DN	PRL08-2DN	PRS12-2DN	PRS12-4DN	PRL18-5DN	PRL18-8DN	PRL30-10DN	PRL30-15DN
	PRL08-1.5DP	PRL08-2DP	PRS12-2DP	PRS12-4DP	PRL18-5DP	PRL18-8DP	PRL30-10DP	PRL30-15DP
	PRL08-1.5DN2	PRL08-2DN2	PRS12-2DN2	PRS12-4DN2	PRL18-5DN2	PRL18-8DN2	PRL30-10DN2	PRL30-15DN2
	PRL08-1.5DP2	PRL08-2DP2	PRS12-2DN2	PRS12-4DP2	PRL18-5DP2	PRL18-8DP2	PRL30-10DP2	PRL30-15DP2
Sensing distance	1.5mm ±10%	2mm ±10%	2mm ±10%	4mm ±10%	5mm ±10%	8mm ±10%	10mm ±10%	15mm ±10%
Hysteresis	Max. 10% of sensing distance							
Standard sensing target	8×8×1mm (Iron)		12×12×1mm (Iron)		18×18×1mm (Iron)	25×25×1mm (Iron)	30×30×1mm (Iron)	45×45×1mm (Iron)
Setting distance	0 ~ 1.05mm	0 ~ 1.4mm	0 ~ 1.4mm	0 ~ 2.8mm	0 ~ 3.5mm	0 ~ 5.6mm	0 ~ 7mm	0 ~ 10.5mm
Power supply (Operation voltage)	12-24VDC (10-30VDC)							
Leakage current	Max. 10mA							
Response frequency(*1)	1.5kHz	1kHz	1.5kHz	500Hz		350Hz	400Hz	200Hz
Residual voltage	Max. 1.5V							
Affection by Temp.	±10% Max. for sensing distance at +20°C within temperature range of -25 ~ +70°C, PR08 Series:Max. ±20%							
Control output	200mA							
Insulation resistance	Min. 50MΩ (at 500VDC)							
Dielectric strength	1500VAC 50/60Hz for 1minute							
Vibration	1mm amplitude at frequency of 10 ~ 55Hz in each of X, Y, Z directions for 2 hours							
Shock	500m/s ² (50G) in X, Y, Z direction for 3 times							
Indicator	Operation indicator (Red LED)							
Ambient temperature	-25 ~ +70°C (at non-freezing status)							
Storage temperature	-30 ~ +80°C (at non-freezing status)							
Ambient humidity	35 ~ 95%RH							
Protection circuit	Surge, Reverse power polarity, Overcurrent protection circuit							
Protection	IP67 (IEC standard)							
Cable spec.	φ4×3P, 2m				φ5×3P, 2m			
Approval	CE							
Unit weight	Approx. 36g	Approx. 36g	PR:Approx. 70g PRS:Approx. 68g	PR:Approx. 70g PRS:Approx. 68g	PR:Approx. 119g PRL:Approx. 150g	PR:Approx. 118g PRL:Approx. 150g	PR:Approx. 184g PRL:Approx. 222g	PR:Approx. 181g PRL:Approx. 227g

*(*1) The response frequency is the average value. The standard sensing target is used and the width is set as 2 times of the standard sensing target, 1/2 of the sensing distance for the distance.

●AC 2-wire type

Model	PR12-2AO	PR12-4AO	PR18-5AO	PR18-8AO	PR30-10AO	PR30-15AO
	PR12-2AC	PR12-4AC	PR18-5AC	PR18-8AC	PR30-10AC	PR30-15AC
			PRL18-5AO	PRL18-8AO	PRL30-10AO	PRL30-15AO
			PRL18-5AC	PRL18-8AC	PRL30-10AC	PRL30-15AC
Sensing distance	2mm ±10%	4mm ±10%	5mm ±10%	8mm ±10%	10mm ±10%	15mm ±10%
Hysteresis	Max. 10% of sensing distance					
Standard sensing target	12×12×1mm (Iron)		18×18×1mm (Iron)	25×25×1mm (Iron)	30×30×1mm (Iron)	45×45×1mm (Iron)
Setting distance	0 ~ 1.4mm	0 ~ 2.8mm	0 ~ 3.5mm	0 ~ 5.6mm	0 ~ 7mm	0 ~ 10.5mm
Power supply (Operation voltage)	100-240VAC (85-264VAC)					
Leakage current	Max. 2.5mA					
Response frequency(*1)	20Hz					
Residual voltage	Max. 10V					
Affection by Temp.	±10% Max. for sensing distance at +20°C within temperature range of -25 ~ +70°C					
Control output	5 ~ 150mA			5 ~ 200mA		
Insulation resistance	Min. 50MΩ (at 500VDC)					
Dielectric strength	2500VAC 50/60Hz for 1minute					
Vibration	1mm amplitude at frequency of 10 ~ 55Hz in each of X, Y, Z directions for 2 hours					
Shock	500m/s ² (50G) in X, Y, Z direction for 3 times					
Indicator	Operation indicator (Red LED)					
Ambient temperature	-25 ~ +70°C (at non-freezing status)					
Storage temperature	-30 ~ +80°C (at non-freezing status)					
Ambient humidity	35 ~ 95%RH					
Protection circuit	Surge protection circuit					
Protection	IP67 (IEC standard)					
Cable spec.	φ4×2P, 2m			φ5×2P, 2m		
Approval	CE					
Unit weight	Approx. 66g	Approx. 66g	PR : Appox. 130g PRL : Appox. 150g	PR : Appox. 130g PRL : Appox. 150g	PR : Appox. 185g PRL : Appox. 224g	PR : Appox. 117g PRL : Appox. 222g

*(*1) The response frequency is the average value. The standard sensing target is used and the width is set as 2 times of the standard sensing target, 1/2 of the sensing distance for the distance.

- (A) Counter
- (B) Timer
- (C) Temp. controller
- (D) Power controller
- (E) Panel meter
- (F) Tacho/Speed/Pulse meter
- (G) Display unit
- (H) Sensor controller
- (I) Switching power supply
- (J) Proximity sensor
- (K) Photo electric sensor
- (L) Pressure sensor
- (M) Rotary encoder
- (N) Stepping motor & Driver & Controller
- (O) Graphic panel
- (P) Production stoppage models & replacement

PR Series

■ Dimensions

(Unit:mm)

●PR(T)08-1.5D□



●PR(T)08-2D□



●PR(T)18-5D□



●PR(T)18-8D□



●PRS12-2D□



●PRS12-4D□

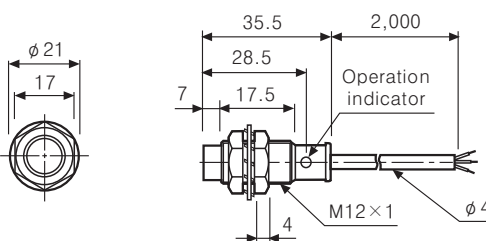

●PR(T)30-10D□



●PR(T)30-15D□



●PR(T)12-2D□

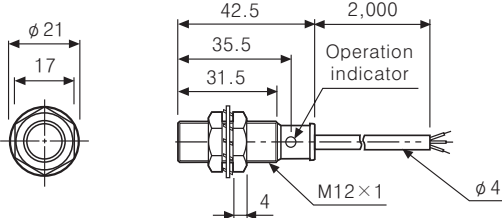

●PR(T)12-4D□



●PRL08-1.5D□



●PRL08-2D□



Cylindrical Type Proximity Sensor

Dimensions

(Unit:mm)

●PRL12-4D□



●PR12-2A□



●PR12-4A□



●PRL18-5D□



●PRL18-5A□

●PR18-5A□

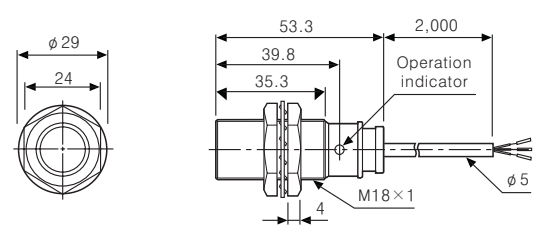

●PRL18-8D□



●PRL18-8A□

●PR18-8A□

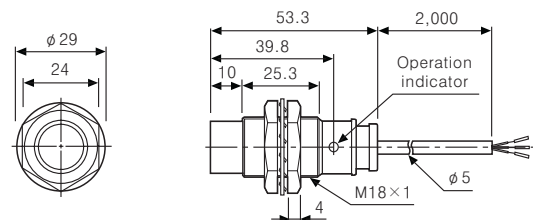

●PRL30-10D□



●PRL30-10A□

●PR30-10A□



●PRL30-15D□

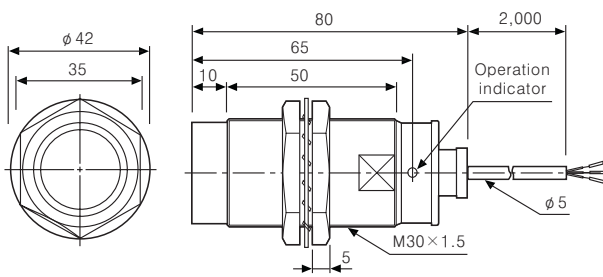

●PRL30-15A□

●PR30-15A□

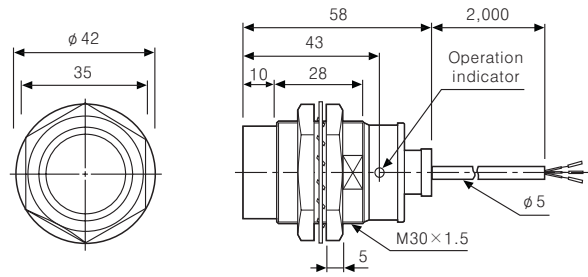

- (A) Counter
- (B) Timer
- (C) Temp. controller
- (D) Power controller
- (E) Panel meter
- (F) Tacho/Speed/Pulse meter
- (G) Display unit
- (H) Sensor controller
- (I) Switching power supply
- (J) Proximity sensor
- (K) Photo electric sensor
- (L) Pressure sensor
- (M) Rotary encoder
- (N) Stepping motor & Driver & Controller
- (O) Graphic panel
- (P) Production stoppage models & replacement

PR Series

Control output diagram

DC 2-wire type



DC 3-wire type



AC 2-wire type



Connections

DC 2-wire type



※The load can be connected to either wire.

DC 3-wire type



AC 2-wire type

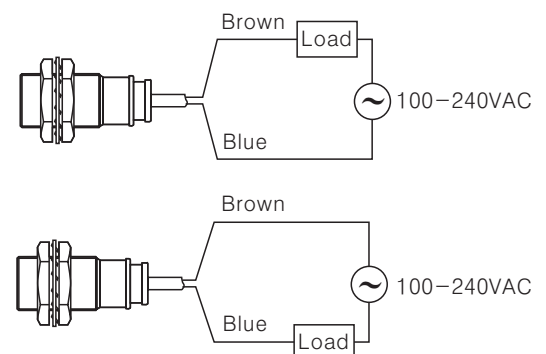

※The load can be connected to either wire.

Cylindrical Type Proximity Sensor

■ Proper usage

○ Load connections



When using DC or AC 2-wire type proximity sensor, the load must be connected, otherwise internal components may be damaged. And the load can be connected to either wire.

○ In case of the load current is small

● AC 2-wire type



It may cause return failure of load by residual voltage. If the load current is under 5mA, please make sure the residual voltage is less than the return voltage of the load by connecting a bleeder resistor in parallel with the load as shown in the diagram.

$$R = \frac{V_s}{I} \text{ (}\Omega\text{)} \quad P = \frac{V_s^2}{R} \text{ (W)}$$

[I: Action current of load, R: Bleeder resistance, P: Permissible power]

● DC 2-wire type



Please make the current on proximity sensor smaller than the return current of load by connecting a bleeder resistor in parallel. ※ W value of Bleeder resistor should be bigger for proper heat dissipation.

$$R = \frac{V_s}{I_o - I_{off}} \text{ (}\Omega\text{)} \quad P = \frac{V_s^2}{R} \text{ (W)}$$

[Vs : Power supply, Io : Min. action current of proximity sensor
Ioff : Return current of load, P : Number of Bleeder resistance watt]

○ Mutual-interference & Influence by surrounding metals

When several proximity sensors are mounted closely, malfunction of sensor may be caused due to mutual interference. Therefore, be sure to provide a minimum distance between the two sensors, as below charts.

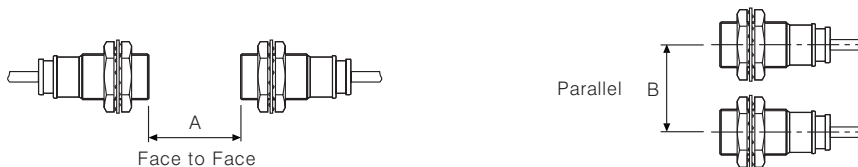

When sensors are mounted on metallic panel, it is required to protect the sensors from being affected by any metallic object except target. Therefore, be sure to provide a minimum distance as below chart.

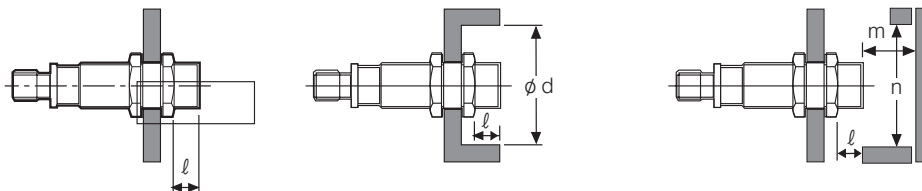

(Unit:mm)

Model	PR08-1.5D□ PRT08-1.5D□	PR08-2D□ PRT08-2D□	PR(T)12-2D□ PRS12-2D□ PR12-2A□	PR(T)12-4D□ PRS12-4D□ PR12-4A□	PR(T)18-5D□ PRL18-5D□ PR18-5A□ PRL18-5A□	PR(T)18-8D□ PRL18-8D□ PR18-8A□ PRL18-8A□	PR(T)30-10D□ PRL30-10D□ PR30-10A□ PRL30-10A□	PR(T)30-15D□ PRL30-15D□ PR30-15A□ PRL30-15A□
A	9	12	12	24	30	48	60	90
B	16	24	24	36	36	54	60	90
l	0	8	0	11	0	14	0	15
φd	8	24	12	36	18	54	30	90
m	4.5	6	6	12	15	24	30	54
n	12	24	18	36	27	54	45	90

(A) Counter

(B) Timer

(C) Temp. controller

(D) Power controller

(E) Panel meter

(F) Tacho/Speed/Pulse meter

(G) Display unit

(H) Sensor controller

(I) Switching power supply

(J) Proximity sensor

(K) Photo electric sensor

(L) Pressure sensor

(M) Rotary encoder

(N) Stepping motor & Driver & Controller

(O) Graphic panel

(P) Production stoppage models & replacement